

Kitchen & Sink Faucets **Installation Tips**

PLEASE NOTE THE FOLLOWING POINTS BEFORE MOUNTING:

- CAUTION WATER DAMAGE POSSIBLE! Please turn off the general water supply before mounting.
- Make sure that all gaskets are correctly seated.
- Fitting for use in private households! Exclusively suitable for use in rooms with a temperature above 0 °C, in case of danger of frost interrupt the water supply and drain the valve.
- Before first use and if the valve has not been used for a long time, allow a go through of a larger amount of water before using as drinking water.
- Use pliers only when tightening the S-connectors.

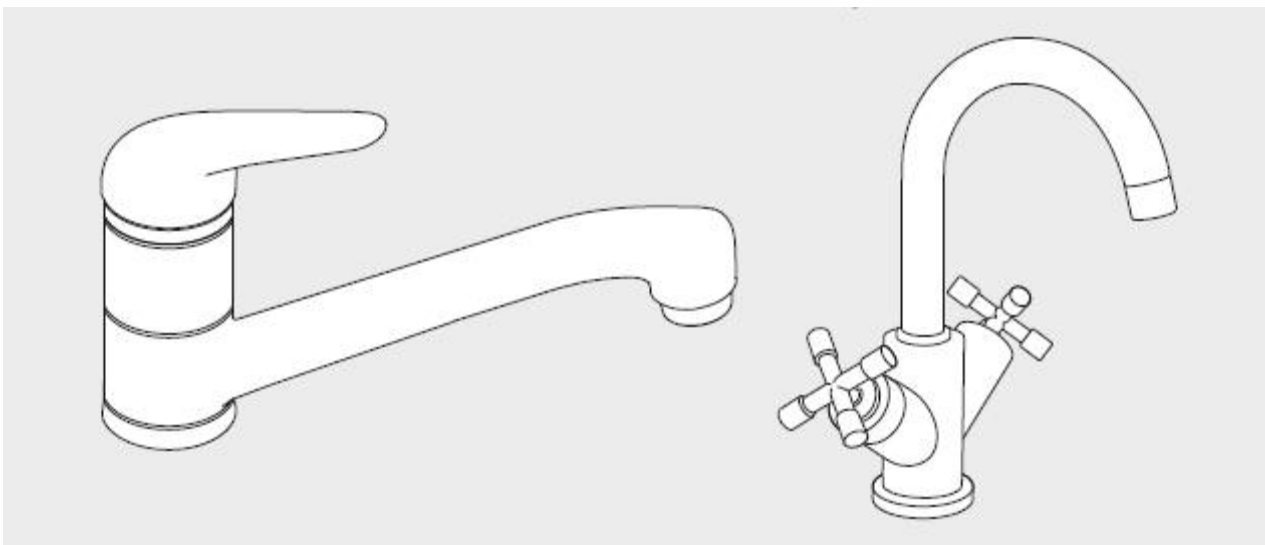

One lever Shower Faucets

2-handle Shower Faucets

Contents

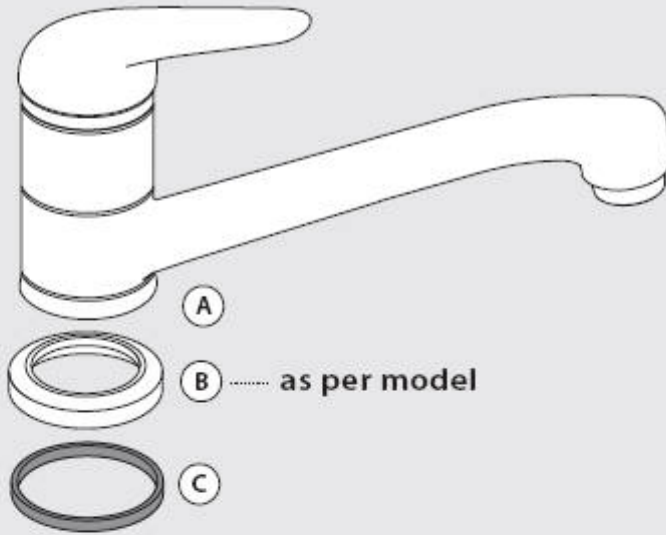

A
 B as per model
 C

One Lever Faucets

or



2-Handle Faucets

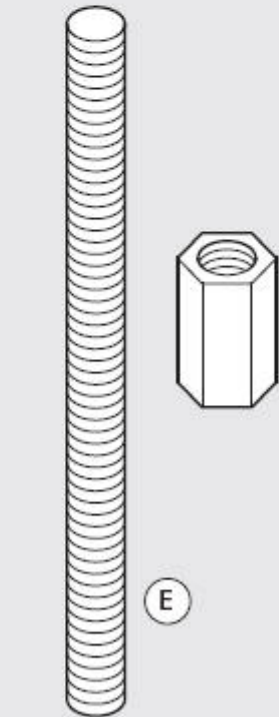
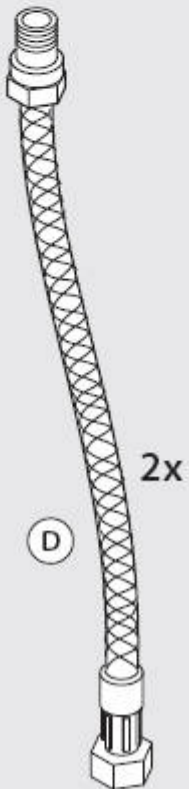

as per model
 1x OR 2x

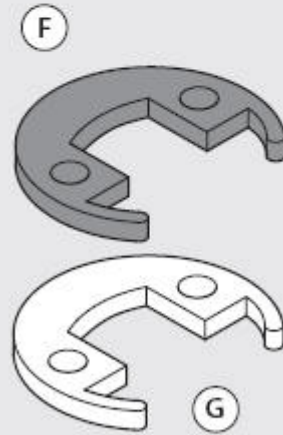

Tools

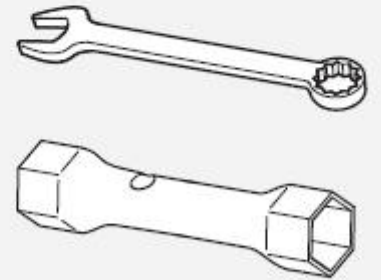

Mounting

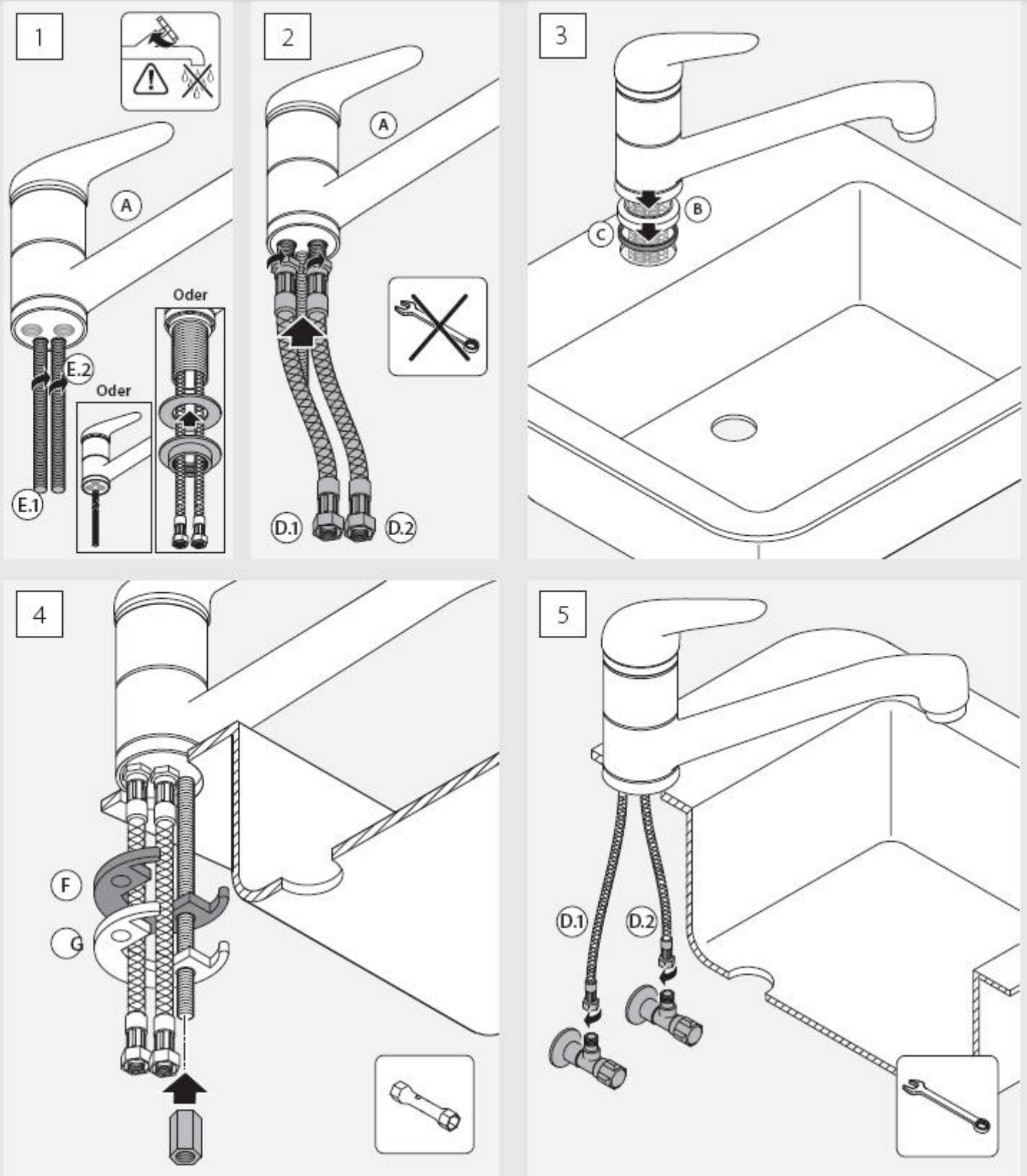

6

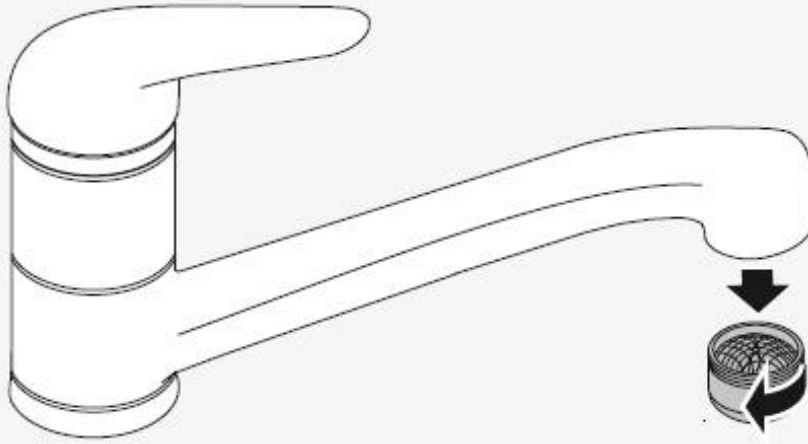

7

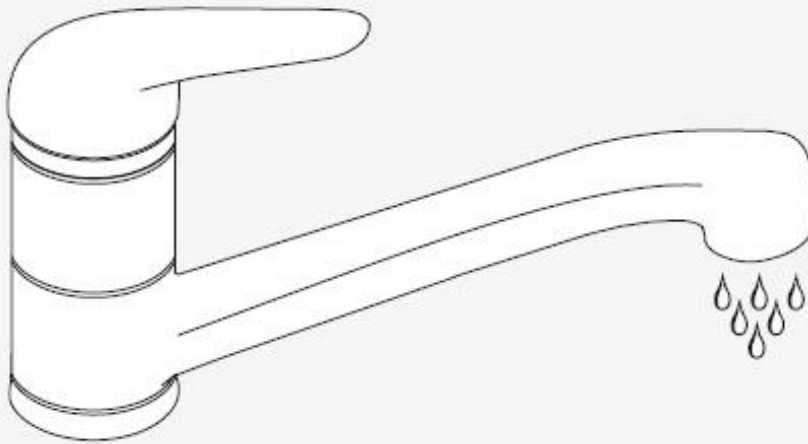

8

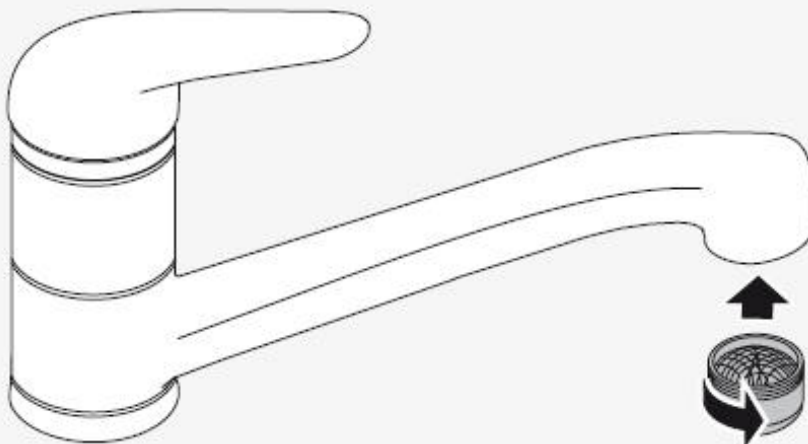

Care Instructions:

- This item is sensitive to limescale removal substances, acidic cleaners and all kinds of Abrasives. Do not use aggressive, chemical or solvent-based cleaning agents or abrasive powder and sponges.
- unscrew the aerator at regular intervals, clean from limescale and/or foreign bodies. Replace the aerator in case of need.
- Dry faucet after use/cleaning to avoid limescale spots.

Troubleshooting:

- IT CRACKS IN THE PIPING LINE WHEN CLOSING THE FAUCET– WHY?
Normally this is not because of the faucet it self. The reason might be in the main piping network. In certain circumstances, the line pressure might be too high. A pressure reducer can help.
- MY FAUCET BECOMES DIFFICULT TO HANDLE. WHY IS IT? WHAT TO DO?
Over the course of time, limescale can cause a binding within the cartridge. The faucet should be disassemble, cleaned and after greasing reassembled.
- HOW TO CHANGE THE FAUCET CARTRIDGE?
- APPLIES ONLY FOR SINGLE LEVER FAUCETS -
First, close the angle valves. With help of an Allen key / screwdriver detach the lever handle (either at the front side under the warm / cold Identification or on the back side of the faucet lever). Then take off the rosette, loosen the Fixing nut of the cartridge and put a new Cartridge. The cams of the cartridge need snap into the holes of the faucet. Put the valve in reverse Order together.
- HOW TO CHANGE THE COMPRESSION UPPER PART?
- APPLIES ONLY FOR 2-HANDLE FAUCETS -
First, close the angle valves. Dismantle the handle, then replace upper part.
- THE FAUCET HANDLE IS LOOSE. WHAT CAN I DO?
Using a screwdriver / Allen key, the mounting screw can be tighten.
- HOW DO I REMOVE LIME RESIDUES?
Clean product only with a soft, damp cloth or leather. Remove possible limescale deposits with household vinegar.
- HOW DO I CLEAN THE PERLATOR?
Unscrew the aerator and sunk for several hours (overnight) in a glass of vinegar. After that, good Rinse and fix back.